

Minimal environmental impact

Low power consumption

bizhub 368/308 minimises energy use during normal operation. It easily clears the latest Energy Star Program TEC standards and reduces both CO₂ emissions and TCO.

TEC values (kWh)

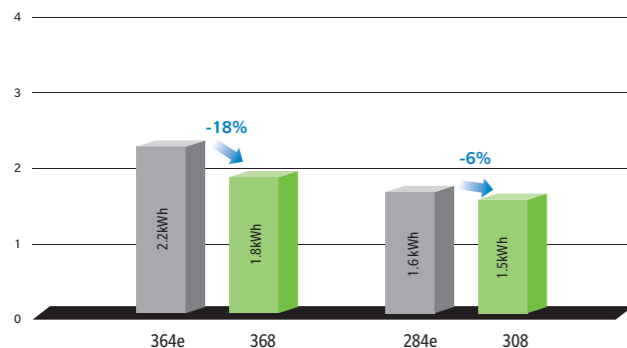

Note: TEC values applied to the International Energy Star Program Version 2.0 (220- to 240-volt specification).

Sleep mode

bizhub 368/308 automatically switches to sleep mode after a user-defined period of inactivity. This mode reduces power consumption to a mere 0.5W by cutting off power to the CPU. When users want to use bizhub 368/308 again, it switches back to full power in seconds.

Eco-friendly materials

Approximately 78% of the outer surfaces and 36% of the weight of resin parts on bizhub 368/308 consist of recycled materials. This includes PC/PET developed by Konica Minolta using advanced chemical processing technology. 70% of PC/PET on surfaces within the unit is PCR (post-consumer recycled).



bizhub 368/308

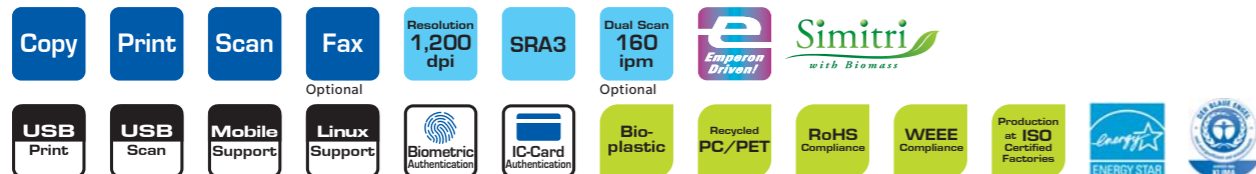

http://www.biz.konicaminolta.com/bw/558_458_368_308/index.html

Product appearance, configuration and/or specifications are subject to change without notice. This product is not available for some countries or regions.

KONICA MINOLTA, the KONICA MINOLTA logo, symbol mark, Giving Shape to Ideas, bizhub, PageScope, Simitri, Emperon, i-Option, INFO-Palette, Konica Minolta Optimised Print Services and their respective logos are registered trademarks or trademarks of KONICA MINOLTA, INC. Google, Android and Google Cloud Print are registered trademarks or trademarks of Google Inc. in the U.S. and other countries. Windows, Excel and PowerPoint are registered trademarks or trademarks of Microsoft Corporation in the U.S. and other countries. Mac, Mac OS, iPhone, iPad, iPod touch and AirPrint are registered trademarks or trademarks of Apple Inc. in the U.S. and other countries. iOS is a registered trademark or trademark of Cisco in the U.S. and other countries. Bluetooth is a registered trademark or trademark of Bluetooth SIG, Inc. Adobe and PostScript are registered trademarks or trademarks of Adobe Systems Incorporated in the U.S. and other countries. Citrix is a registered trademark or trademark of Citrix Systems, Inc in the U.S. and other countries. Linux is a registered trademark or trademark of Linux Torvalds in the U.S. and other countries. Unix is a registered trademark or trademark of The Open Group. SAP is a registered trademark or trademark of SAP AG. Mopria is a registered trademark or trademark of Mopria Alliance Inc. NFC is a registered trademark or trademark of the NFC Forum. Felica is a registered trademark or trademark of Sony Corporation. SSFC is a registered trademark or trademark of Dai Nippon Printing Co., Ltd. MIFARE is a registered trademark or trademark of NXP B.V. IEEE is a registered trademark or trademark of The Institute of Electrical and Electronics Engineers, Inc. All other brands and product names are registered trademarks or trademarks of their respective companies or organisations.



From consulting, system design, to operations, Konica Minolta offers total support to optimise your office output environment.

<http://www.biz.konicaminolta.com/services/ops>

Requirements for safe use

- Please read and follow the instruction manual to ensure safe operation.
- Only operate using appropriate power supply and voltage.
- Connecting the earth wire to an inappropriate place may cause explosion or electric shock. Please connect accordingly (Taiwan and the Philippines only).

KONICA MINOLTA, INC.
2-7-2 Marunouchi Chiyoda-ku, Tokyo, Japan
<http://www.biz.konicaminolta.com>



KONICA MINOLTA

bizhub 368/308

A3



368 BW 36 PPM

308 BW 30 PPM

Boost everyday business productivity

Achieve higher productivity with Konica Minolta bizhub 368/308. Swiftly output monochrome documents at high resolution. Intuitively take advantage of feature-rich capabilities. Securely handle confidential business data. And flexibly complete high-volume jobs with advanced paper finishing options. Professional quality production of business documents has never been easier.



20 sec.

Warm-up time

20 seconds or less on bizhub 368/308
(18 seconds or less on bizhub 308 from sub-power mode)

160 ipm

Single-pass duplex scanning

When equipped with DF-704

5.0 sec.

First copy time

bizhub 368 (5.4 seconds on bizhub 308)

36 ppm

Output

bizhub 368 (30 ppm on bizhub 308)

User-friendly multi-touch screen

The 9-inch multi-touch screen presents information with clarity in an intuitive user interface that everyone can understand.

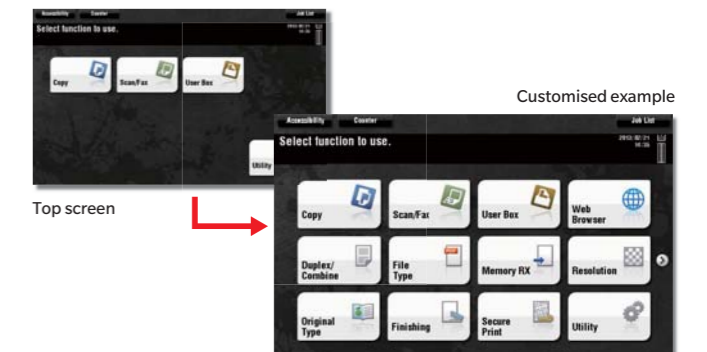

Connection with mobile devices

Industry standard mobile technologies allow mobile devices to link with bizhub 368/308 and wirelessly command printing as well as other features.



Simple, solid security

Flexible authentication support, easy initial security setup and other security conveniences simplify protection of company assets.



A more efficient, streamlined workflow

Operational ease and efficiency

User-friendly multi-touch screen

Operation is simplified by a user-friendly 9-inch multi-touch screen with intuitive user interface. The same touch gestures used on mobile devices can be used on the touch screen to simplify operation. Tap to select, double tap to activate, flick to scroll or pinch to magnify. Up to 23 shortcut keys can be set in the main menu for quick and easy access to frequently used functions.

INFO-Palette design

Whether users operate bizhub 368/308 from its intuitive touch screen or from a connected PC or mobile device installed with our software, the same intuitive user interface is shared to make operation a breeze.

Paper capacity

The standard 1,150-sheet paper capacity can be increased to 3,650 sheets by adding the optional Paper Feed Cabinet. It can be further increased to 6,650 sheets by also adding the optional Large Capacity Unit. Higher capacities let users handle higher-volume workloads with less downtime for paper replenishment.

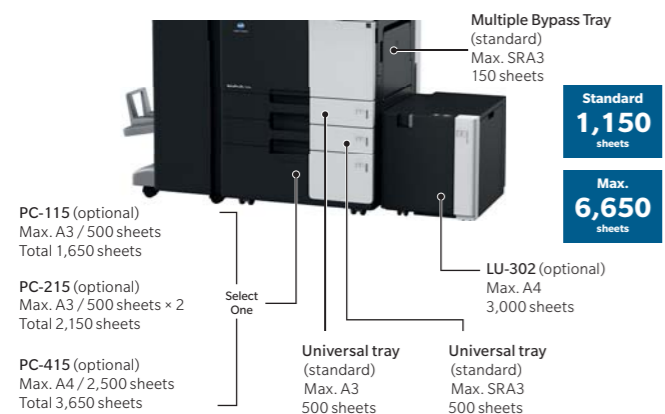

*The paper supply capacity for all models is based on 80 g/m².

High-speed colour scanning

Colour hardcopies are scanned with precision and speed on optional Dual Scan Document Feeder DF-704. Just place hardcopies in the feeder and press the Scan button to scan one-sided pages at 80 ipm (simplex) and two-sided pages at 160 ipm (duplex).*

*When feeding A4 paper sideways (at 300 dpi resolution)



Hardcopy digitisation

Scanned hardcopies can be saved as searchable PDFs¹ or editable files in the PowerPoint, Excel or Word format². The files are small with excellent image quality and can be saved in the internal HDD or mobile devices.

¹ Optional i-Option LK-102 v3 or LK-110 v2 is required.
² Editable Excel/Word formats require optional i-Option LK-110 v2.
Note: Optional upgrade Kit UK-211 is required.

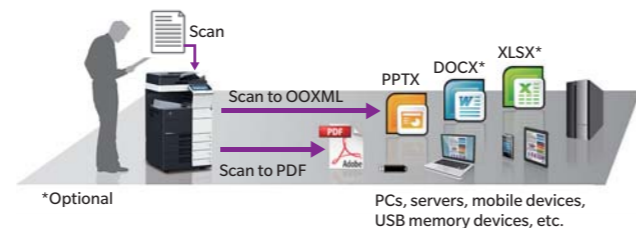

Optional finishers

Three optional finishers are available for post-processing tasks. Optional finishers FS-536 and FS-536SD include stapling functions (up to 50 sheets), a 3,000-sheet capacity unit (2,000 sheets on FS-536SD), booklet functions, folding functions and more. Optional inner finisher FS-533 handles stapling from within compact bizhub dimensions.



Features	Finishing image	FS-536 ^{1,2}	FS-536SD ^{1,2}	FS-533	JS-506
Sorting (offset sorting)	Paper output position is shifted for each set	○	○	○	○
Stapling	Corner stapling (diagonal) Corner stapling (parallel) ³ Two-point stapling (parallel) ³	Thin/normal (52–90g/m ²): 50 sheets Thick (91–120g/m ²): 30 sheets Extra thick (121–209g/m ²): 15 sheets	Thin/normal (52–90g/m ²): 50 sheets Thick (91–120g/m ²): 30 sheets Extra thick (121–209g/m ²): 15 sheets	Max. 50 sheets ⁴ (52–90g/m ²)	–
Saddle stitching (booklet) & folding	Booklet Centre-fold Letter-fold	–	Max. 20 sheets	–	–
Punching	Two-hole punch Upper two-hole punch	Punch kit PK-520 (up to 300g/m ²)	Punch kit PK-520 (up to 300g/m ²)	Punch kit PK-519 (up to 157g/m ²)	–
Cover sheet & insert sheet	Cover sheet Insert sheet	○	○	○	○

¹ Paper output to the main body is possible. Up to three output destinations can be set.

² Relay unit RU-513 is required.

³ Parallel stapling is only compatible with A4/B5 vertical and A5 horizontal on FS-536/FS-536SD.

⁴ Diagonal corner stapling is not possible.

Easy connectivity

Connect with mobile devices

Enjoy a flexible mobile work style by using bizhub 368/308 together with iOS, Android and Windows 10 mobile devices. Users can take advantage of printing and other bizhub features through their favourite industry standard mobile technologies (see right).

Convenient Mobile Touch Area

Pair Android mobile devices¹ with bizhub 368/308 by simply holding them close to the Mobile Touch Area on the multi-touch screen. NFC (Near Field Communication) ensures smooth, quick connections. The Mobile Touch Area can also be used to log in, print files, scan documents and import scanned data². iOS devices pair using Bluetooth LE (BLE)³.

¹ Android OS 4.4 or higher and PageScope Mobile must be installed.

² Initial setup required for logging in. Wireless LAN environment required for printing and scanning.

³ Optional Device Connection I/F Kit EK-609 is required.



Wireless LAN*

Access Point mode and Simple Access Point mode via Wireless LAN allow computers and mobile devices in your office to wirelessly connect with bizhub 368/308. This creates a fully independent network that supports BYOD (bring your own device) without additional investment. Connection with your company's existing wireless LAN is also supported.

*Optional upgrade Kit UK-212 or UK-215 is required.



bizhub Remote Access

The bizhub Remote Access app allows operation of bizhub 368/308 from Android devices and iPhone/iPad/iPod touch. Users can wirelessly operate bizhub hardware and software keys, enter data, import scanned data, send data from bizhub 368/308 using the mobile device's address book and more.

Connect instantly without print drivers to industry standard mobile technologies

	iOS	Android	Windows 10 Mobile
<p>AirPrint Print from any compatible printer on your company's wireless LAN using AirPrint, Apple's standard printing system. It is compatible with iOS 4.2 and Mac OS 10.7 or later.</p>	✓		
<p>Mopria Print Service This wireless printing technology provides a universal print driver for printing from devices installed with Android 4.4 or later.</p>		✓	
<p>Google Cloud Print Leading technology connects bizhub 368/308 with the web so users can print from anywhere outside the office regardless of OS, device or application. Notes: Google Cloud Print Setup and Google account registration are required.</p>	✓	✓	
<p>Konica Minolta Print Service This application enables printing directly from devices running Android 4.4 or later through your company's wireless LAN.</p>		✓	
<p>PageScope Mobile Connect mobile devices with bizhub 368/308 via Wi-Fi to print documents and images as well as import scanned data — by using PageScope Mobile for Android or iPhone/iPad.</p>	✓	✓	✓



Peace of mind meets feature-rich flexibility

Solid security

Easy authentication

Smooth and efficient password, IC card and biometric (finger vein) authentication are supported. In addition to regular authentication via server, server-free authentication can also be performed directly on the main unit with detailed control of access to each function, including copying, printing, scanning and faxing. These features complement your company's existing security measures to protect important data and hardcopy resources, prevent unauthorised bizhub access and strengthen risk management.

IC card authentication

Authentication is possible with various types of IC card. First command bizhub 368/308 to print from a PC or mobile device. Then wave the IC card over a card reader on bizhub 368/308 to print. Authentication can also be performed with any Android device* equipped with an NFC antenna.

*Requires Android 4.4 or later that supports HCE (Host Card Emulation) or PageScope Mobile for Android v4.1 or later.
Notes: Optional Authentication Unit AU-201S is required. Compliant non-contact IC cards include FeliCa (IDm), SSFC, FCF, FCF (campus), FeliCa Private and MIFARE (UID).



Biometric finger-vein authentication

Finger vein biometric authentication is easy to implement and makes forged access virtually impossible. After commanding bizhub 368/308 to print from a PC or mobile device, the authorised user just scans his or her finger at bizhub 368/308 to print.

Note: Optional Biometric Authentication Unit AU-102 and Working Table WT-506 are required.



TPM (Trusted Platform Module)

Confidential information such as certificates and passwords can be securely managed in bizhub 368/308. Just activate the TPM function to encrypt the information and save it in a dedicated storage area in the TPM security chip. This prevents unauthorised reading from external devices.

*Optional i-Option LK-115 v2 is required.

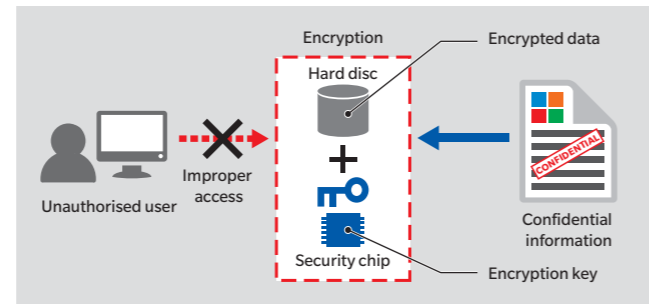

HDD mirroring*

This feature ensures that all data saved on the main HDD is always saved on a backup HDD as well. If the main HDD fails, bizhub 368/308 automatically switches to the backup HDD to prevent operational downtime and data loss.

*Optional HDD Mirroring Kit HD-524 is required.

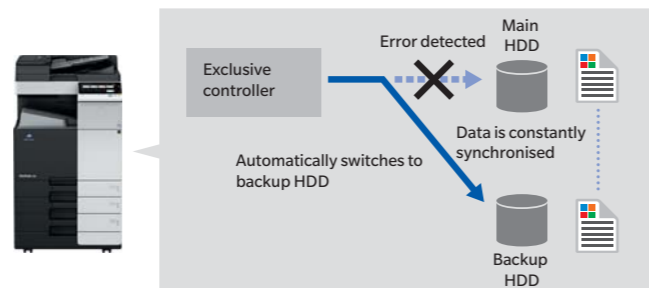

PDF password protection

When saving scanned data as a PDF file, the data can be encrypted to prevent opening of the file unless the user inputs the correct password. The user can also encrypt the PDF with his or her digital certificate, create a PDF/A-based PDF file* and add file properties.

*Optional upgrade Kit UK-211 is required. i-Option LK-102 v3 or LK-110 v2 is also required.

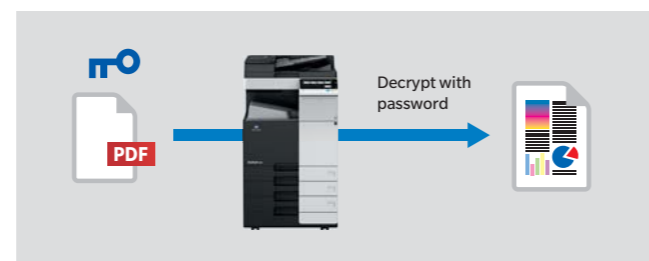

Compliance with industry standards*

This model meets IEEE 2600.1 international protection profile standards, ensuring a high level of document security. All security features have been independently evaluated and certified ISO 15408 EAL3 compliant.

*Application is still pending as of October 2016.

Versatile features

Emperon printing system

Emperon print controller provides network printing functions through standardised printer drivers for PCL and Adobe® PostScript® 3 emulation. Diverse settings allow fine image adjustment such as for glossy mode and edge enhancement. Emperon controller is fully compatible with Windows, Mac, Linux, Unix, Citrix, SAP and other operating systems and printing environments.



N-in-One copying

It's easy to copy multiple pages on a single sheet of paper to reduce paper costs and facilitate viewing of related pages. Users can copy up to 8 pages on a single side of paper when scanning a paper document and up to 16 pages when printing from a file.

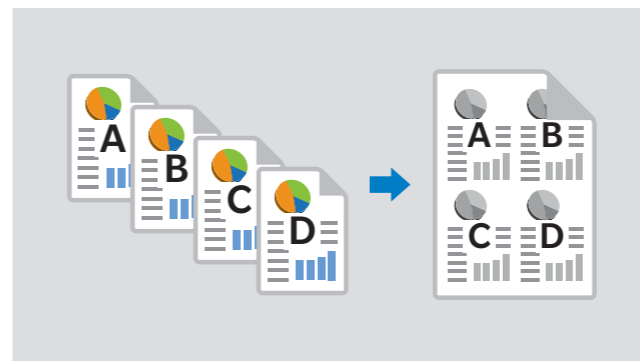

Banner print*

Create appealing promotional materials in-house on bizhub 368/308. Simply select the Banner Print feature and select the file to print. Then place the long paper (up to 1,200mm) in the bypass tray with the paper setting guide flipped up. When ready, print away for big, beautiful results.

*Requires Optional Banner Paper Setting Guide MK-713.



USB port

The USB port allows transferring of files to and from bizhub 368/308 via flash drive. Once a file is stored in bizhub 368/308, it can be used to output documents or transferred to other devices.

Notes: Compatible with PDF, Compact PDF, JPEG, TIFF, XPS, Compact XPS, OOXML (docx, xlsx, pptx) files. Some USB flash drives may not be compatible. Print output may differ from what appears on the PC screen.

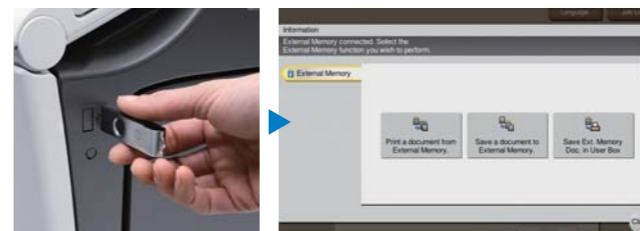

ID copy

This feature makes it easy to print the front and back of an ID card on the top and bottom of a single page. For extra easy access, place an ID Copy shortcut button on the top screen.

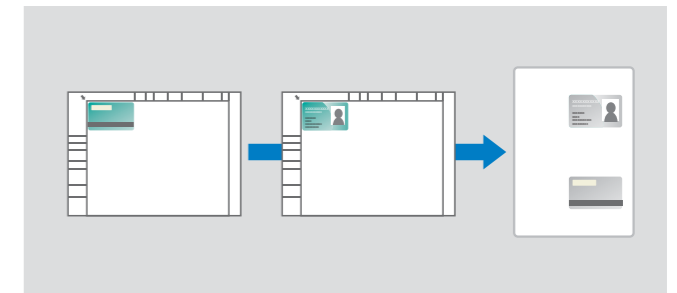

Scan preview

Scanned paper documents can be previewed on the touch screen before saving or sending. Just flick to scroll through pages, rotate them when desired and delete unnecessary pages until satisfied. Then save or send.

Automatic paper size measurement

Automatic paper size measurement can automatically measure the size of non-standard sized paper placed on the glass platen. It can also register the size in memory if desired. These features make it easy for anyone to handle non-standard paper sizes without making measuring mistakes or input errors.

Server-less pull printing

bizhub 368/308 supports server-less pull printing. Users can send data to a main MFP and authenticate themselves at any MFP on the network print group (up to 10 MFPs x 10 groups) to pull the print job.

Note: Optional i-Option LK-114 and Upgrade Kit UK-211 must be installed on bizhub 368/308.

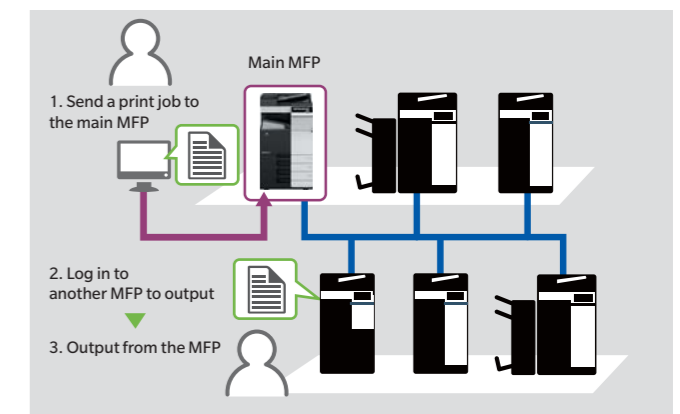

Ubiquitous printing without a server

